







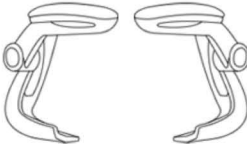
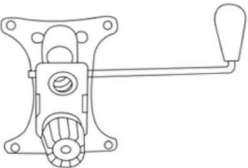
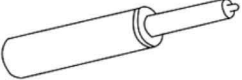

MODEL: B6366

(1)x1  Back Cushion	(2)x1  Seat Cushion	(3)x1 (L)x1 (R)  Left-Arm Right-Arm
(4)x1  Mechanism	(5)x1  Gas Lift W/ Cover	(6)x1  Base
(7)x5  Caster		
<p>(A)x4  M6*22 MECHANISM SCREW</p> <p>(B)x8  M6*35 ARM SCREW</p> <p>(C)x4  CAP</p> <p>(D)x1  ALLEN KEY</p>		

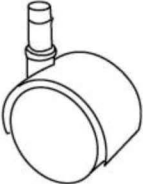

**Insert and loosely tighten all screws. When assembly is completed, fully tighten all screws before using. This chair is only intended for sitting. Any other use will void the warranty.**

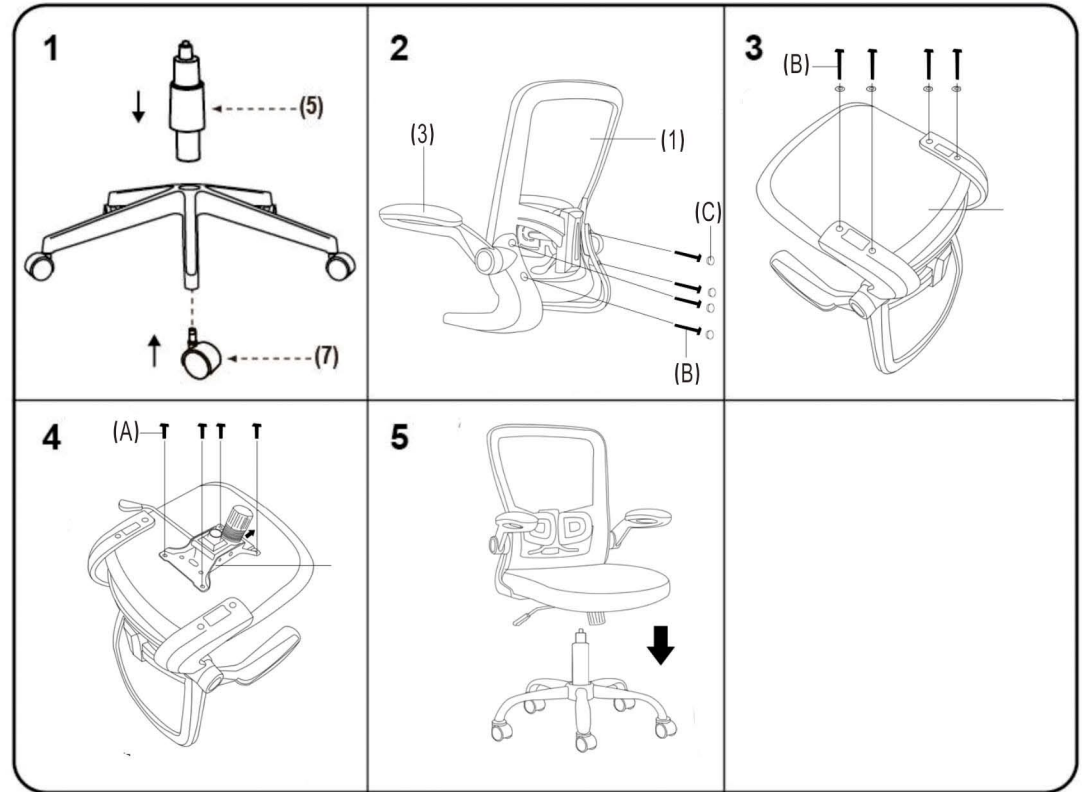