













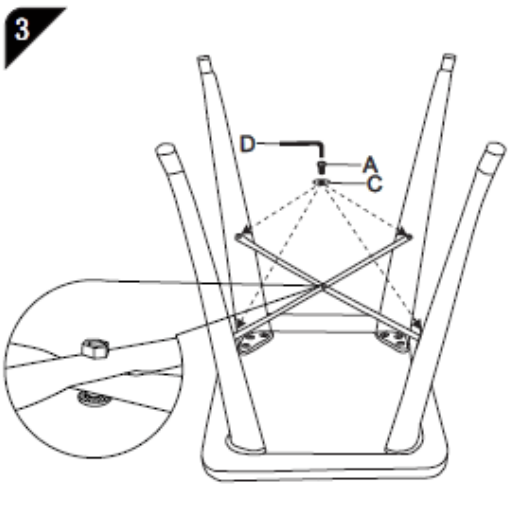
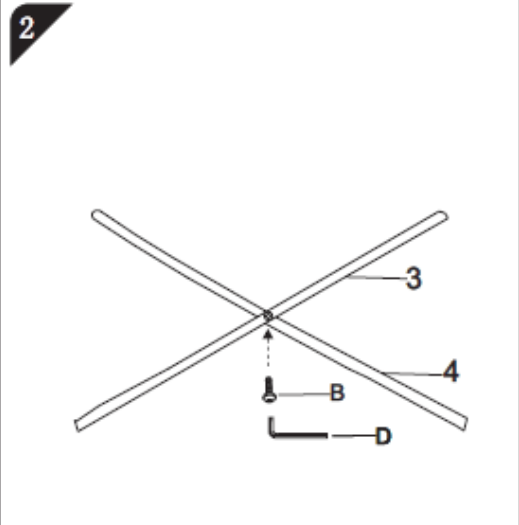
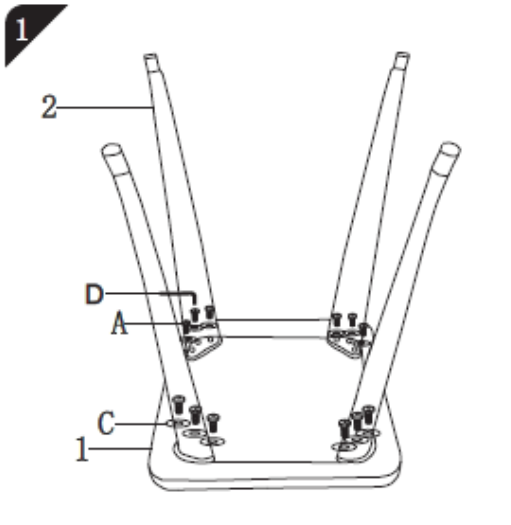

CH-31330M1

PART IDENTIFICATION	QUANTITY PER SET	PART IDENTIFICATION	QUANTITY PER SET
1: 	1	A: 	16
2: 	4	B: 	1
3: 	1	C: 	16
4: 	1	D: 	1



Notes: Please do not fully tight the screw before all screws are fixed.

CH-31230M1D

PART IDENTIFICATION	QUANTITY PER SET	PART IDENTIFICATION	QUANTITY PER SET
A: 	1	D: 	4
B: 	1	E: 	1
C: 	4		

